

BANG & OLUFSEN

BEOLAB® PENTA

For the UK market only:

IMPORTANT!

The wires in the mains lead supplied with this apparatus are coloured in accordance with the following code:

BLUE: NEUTRAL

BROWN: LIVE

As the colours of the wires in the mains lead of this apparatus may not correspond with the coloured markings identifying the terminals in your plug, proceed as follows:

- The wire which is coloured blue must be connected to the terminal which is marked with the letter N or coloured BLACK.
- The wire which is coloured brown must be connected to the terminal which is marked with the letter L or coloured RED.

Ensure that your equipment is connected correctly. If you are in any doubt, consult a qualified electrician.

For the US market only:

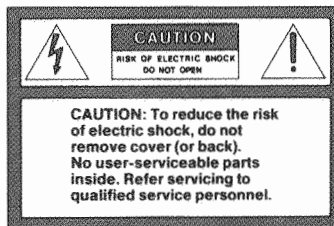

WARNING: To prevent fire or electric shock, do not expose this appliance to rain or moisture.



This symbol indicates that a dangerous voltage constituting a risk of electric shock is present within this unit.



This symbol indicates that there are important operating and maintenance instructions in the literature accompanying this unit.

This equipment generates and uses radio frequency energy and if not installed and used properly, that is, in strict accordance with the manufacturer's instructions, may cause interference to radio and television reception. It has been type tested and found to comply with the limits for a Class B computing device in accordance with the specifications in Subpart J of Part 15 of FCC Rules, which are designed to provide reasonable protection against such interference in a residential installation. However, there is no guarantee that interference will not occur in a particular installation. If this equipment does cause interference to radio or television reception, which can be determined by turning the equipment off and on, the user is encouraged to try to correct the interference by one or more of the following measures:

- Reorient the receiving antenna
- Relocate the computer with respect to the receiver
- Move the computer away from the receiver
- Plug the computer into a different outlet so that computer and receiver are on different branch circuits.

If necessary, the user should consult the dealer or an experienced radio/television technician for additional suggestions. The user may find the following booklet prepared by the Federal Communications Commission helpful:

"How to Identify and Resolve Radio-TV Interference Problems".

This booklet is available from the U.S. Government Printing Office, Washington, DC 20402, Stock No. 004-00345-4.

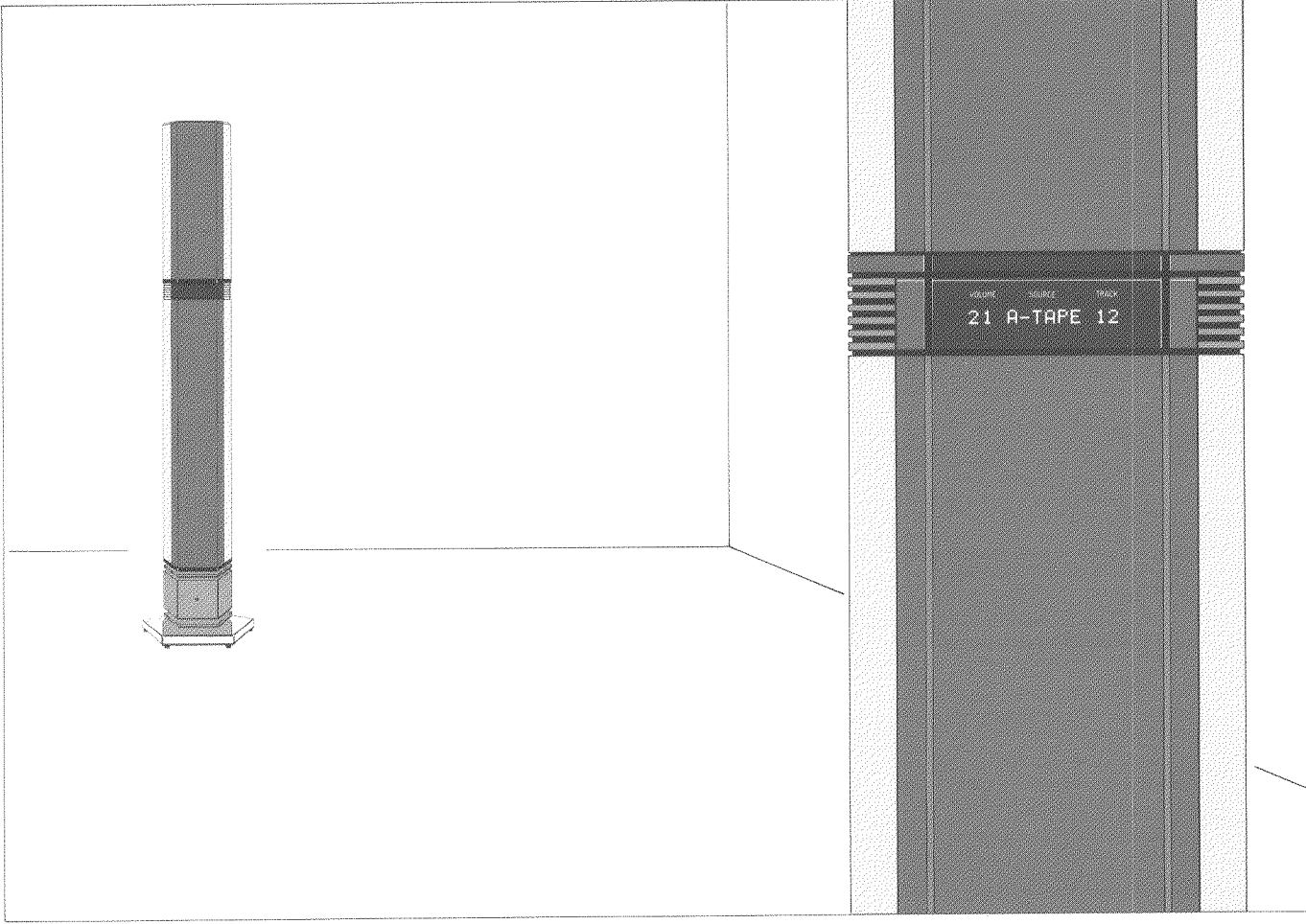

Your Beolab Penta is the top of the line in the Bang & Olufsen range of audio equipment. It consists of the best Bang & Olufsen loudspeaker and amplifier ever, united in a slim, pentagonal sound column with stainless steel finish.

Owing to its sculptural design, the Beolab Penta takes up very little floor space. It adopts the colour of its surroundings and enhances the beauty of your home while giving you extraordinary musical experiences. The Beolab Penta consists of a loudspeaker unit matched by a powerful, fully automatic one-channel amplifier. The amplifier unit is equipped with the Dynamic Clipping Attenuator which reduces any audible distortion. The speaker unit contains a display which gives you useful information about the current state of your audio or video system.

This manual describes how to assemble the Beolab Penta, where to place it and how to connect and adjust it to your Bang & Olufsen audio or video system.

TABLE OF CONTENTS

- 5 Assembling stand and column
- 6 Connections
- 9 Placement
- 10 Setting the front panel switches
- 13 Display
- 15 Dynamic Clipping Attenuator
- 16 Protection circuit
- 16 Optional accessories
- 17 Maintenance
- 18 Developing a Bang & Olufsen loudspeaker
- 19 Technical specifications
- 20 International guarantee

Assembling stand and column

It is easiest to assemble the stand and the column if the column is lying on a table.

In order to protect the table from being scratched, we recommend that you first place the wrapping foam on the table.

The parts required for assembling the Beolab Penta are supplied with the speaker:

- 1 box spanner
- 5 nuts
- 5 plastic feet

- Fasten the stand to the column by hooking the stand onto the 5 bolts fitted to the base of the column.
- Screw the 5 nuts onto the bolts and tighten them securely using the box spanner.

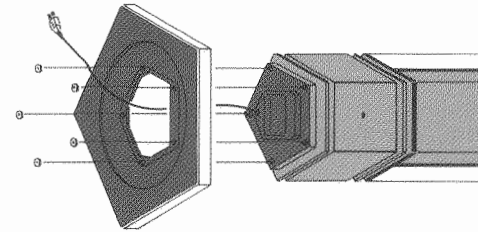

The 5 plastic feet may be used to prevent wooden/parquet floors from being scratched. Insert them into the holes provided under the stand of the speaker.

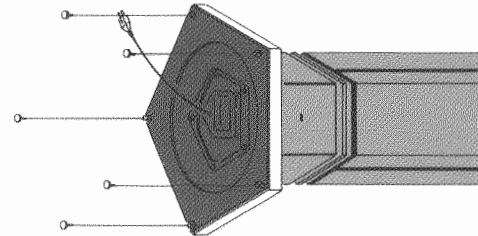

Connections

The Beolab Penta can be connected to either a receiver, a TV set, a Master Control Link 2 A or a Master Control Link 2 AV (MCL 2 A/2 AV).

For lengths and parts numbers of the cables which can be used, see the section "Optional accessories".

NOTE! Before connecting the Beolab Penta to the receiver, TV set or MCL 2 A/2 AV, make sure that the MODE switch on the front panel is set to OFF. This precaution applies to both the initial set-up and to later rearrangements of connections.

Do not switch on your audio or video system until you have set the switches on the front panel to their correct position (see pp 10-12).

Connection to a Bang & Olufsen receiver or TV set or an MCL 2 A/2 AV

When connecting your Beolab Penta, you may use *either* the POWER LINK socket *or* the SPEAKER LINK socket.

○ POWER LINK 1 & POWER LINK 2 sockets (using an 8-pin DIN Power Link cable).

The sockets marked POWER LINK 1 & 2 are identical. This means that either socket can be used when you connect your Beolab Penta by means of a Power Link cable.

- Plug one end of the cable into one of the POWER LINK sockets on the Beolab Penta.
- Plug the other end of the cable into one of the POWER LINK sockets on your receiver, TV set or MCL 2 AV.
- Repeat the procedure for the other speaker.

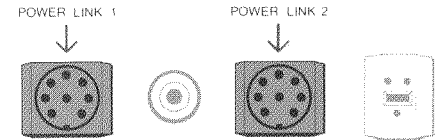

In order to avoid running cables from both speakers to your receiver, TV set or MCL 2 AV, you may loop the signal through as illustrated:

- Using one Power Link cable, connect one speaker to your receiver, TV set or MCL 2 AV.
- Using the other Power Link cable, connect the speakers to one another.

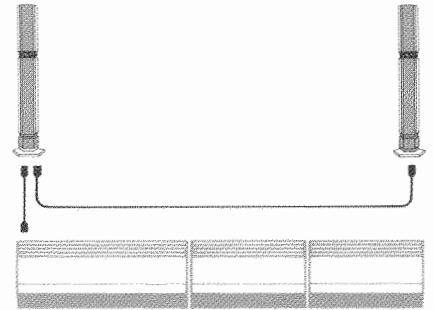

○ SPEAKER LINK socket (using a *shielded* cable with 2-pin, 3-pin or 4-pin DIN speaker plugs)

- Plug one end of the cable into the SPEAKER LINK socket on the Beolab Penta.
- Plug the other end of the cable into the appropriate socket on your receiver, TV set or MCL 2 A/2 AV.
- Repeat the procedure for the other speaker.

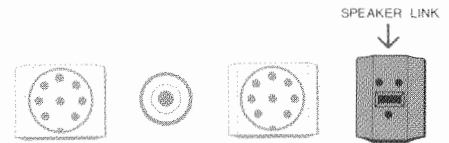

○ AUDIO/VIDEO switch
In order to obtain the correct status reading from the display, the AUDIO/VIDEO switch must be set to the correct position:

- AUDIO if the Beolab Penta is connected to a Beomaster, Beocenter or MCL 2 A/2 AV.
- VIDEO if the Beolab Penta is connected to a Beovision.



Connection to other receivers

When connecting your Beolab Penta, you may use *either* the SPEAKER LINK socket or the LINE IN socket.

○ SPEAKER LINK socket
(using a *shielded* cable with 2-pin DIN speaker plugs)

- Plug one end of the cable into the SPEAKER LINK socket on the Beolab Penta.
- Plug the other end of the cable into the appropriate loudspeaker socket on the receiver.
- Repeat the procedure for the other speaker.

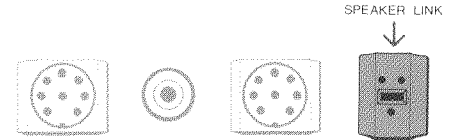

○ LINE IN socket
(using a *shielded* cable with phono plugs)

- Plug the appropriate cable end into the LINE IN socket on the Beolab Penta.
- Plug the other end of the cable into the appropriate phono socket (pre-amplifier output) on your receiver.
- Repeat the procedure for the other speaker.

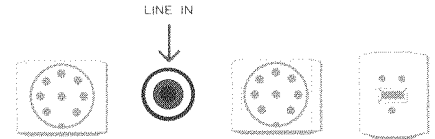

Placement

When the Beolab Penta has been securely fastened to its stand and the connecting cable has been plugged into the appropriate socket, the speaker must be placed vertically on a stable surface.

Make sure that ventilation to the amplifier is not impeded, and do not lean against the Beolab Penta.

Because of its unique design, the Beolab Penta can be placed almost everywhere in your room. However, the ideal sound performance is achieved if the speakers are placed 3 metres apart and if there are 3 metres from the listening position to the centre point between the speakers.

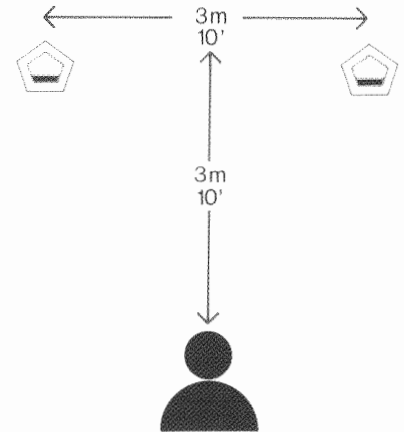

Setting the front panel switches

Before switching on your audio or video system you must set the three switches on the front panel of the amplifier to their correct posi-

INPUT LEVEL switch

Set the INPUT LEVEL switch to the position required to match the Beolab Penta to the output of your receiver or TV set. If in doubt about your receiver/TV output, consult your Bang & Olufsen dealer.

tion. To open the front panel, press gently on the upper middle part of the panel and release.

POWER LINK socket:

If you are using Power Link cables, set the switch to ≡.

SPEAKER LINK socket:

Switch position	Receiver/TV output* 4 ohm	8 ohm
≡	- 40 W	- 20 W
≡	40 - 80 W	20 - 40 W
—	80 - W	40 - W

LINE IN socket:

Switch position	Pre-amplifier output
≡	- 1 V
≡	1 - 1.4 V
—	1.4 - V

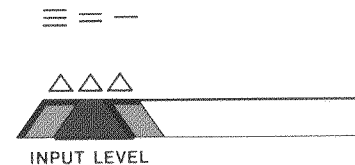

* 4 ohms and 8 ohms receiver/TV output specified for 4 and 8 ohms speaker impedance.

MODE switch

Once connected to the mains supply, the Beolab Penta is in the stand-by mode. The stand-by mode is indicated by a red light on the front of the amplifier unit.

The speaker switches on automatically when it receives a signal, unless, of course, the MODE switch is set to OFF. When the speaker switches on, the light on the front of the amplifier turns green.

Set the MODE switch to either AUTO, L (left) or R (right):

Sockets	MODE switch
<hr/>	
POWER LINK	
Left speaker	L
Right speaker	R
<hr/>	
SPEAKER LINK	
Receiver without built-in loudspeaker relay	AUTO
Receiver with built-in loudspeaker relay	L / R
<hr/>	
LINE IN	AUTO
<hr/>	

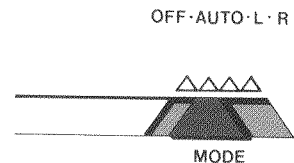

When the signal disappears, the speaker automatically switches off, i.e. reverts to the stand-by mode, after a delay of approx. 10 seconds (MODE switch in L or R position) or approx. 3 minutes (MODE switch in AUTO position).

BASS EXTENSION switch

The BASS EXTENSION switch can be set to three different positions:

- I for no bass equalization
- II for medium bass equalization (+3dB/40 Hz)
- III for maximum bass equalization (+6dB/40 Hz)

The purpose of the BASS EXTENSION switch is to ensure that the bass level suits the environment and the placement of the speaker. Which switch position to choose depends on the distance from the loudspeaker to corners and walls and on the floor area of your room.

The examples given in the table are only meant as a guideline. You may of course set the switch to any of the three positions which you prefer.

We recommend that the BASS EXTENSION switches on the two speakers be set to the same position. If the two speakers cannot be placed in comparatively similar positions related to room boundaries, both BASS EXTENSION switches should be set to the posi-

Placement of speaker in listening room:

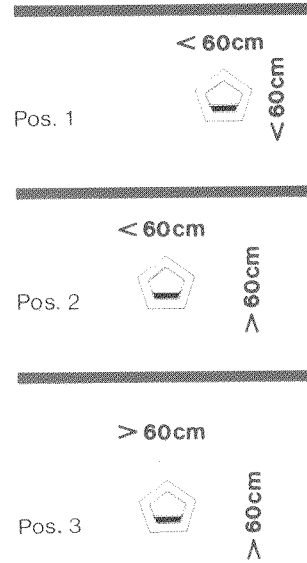

Floor area of listening room:

<30m ²	30-50m ²	>50m ²

(30m² ~ 300 sq feet; 50m² ~ 500 sq feet
60 cm ~ 2')

tion prescribed by the placement of the speaker with the lowest position number in the table.

Display

If connected to a compatible Bang & Olufsen receiver, TV set or MCL 2 A/2 AV, your Beolab Penta displays information about the source of the sound reproduced by the speaker. However, in order to give full status reading in the display, the Beolab Penta must be connected to a Bang & Olufsen product with POWER LINK sockets. If you use a 4-pin DIN shielded speaker cable to connect your Beolab Penta to the

SPEAKER LINK socket on a Bang & Olufsen product equipped with POWER LINK sockets, you still get full reading in the display.

If the Beolab Penta is connected to a product without POWER LINK sockets, the status reading will be either slightly reduced or completely missing, depending on the product. If in doubt about which kind of status reading you can get, consult your Bang & Olufsen dealer.

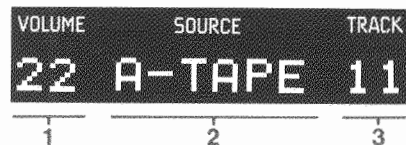

The displayed cues and symbols are not all visible at the same time.

1

VOLUME

22 Volume level
- - Muted

2

SOURCE

RADIO Radio
CD Compact disc player
PHONO Record player
A-TAPE Audio tape recorder
A-TP2 Second audio tape recorder
A-AUX Any source connected to the
 AUX/LINE socket on the
 receiver
TV TV set
V-SAT TV satellite program
V-TAPE Video tape recorder
V-TP2 Second video tape recorder
V-AUX Any source connected to the
 AUX/LINE socket on the TV
 set

Recording:

A-REC Recording on audio tape
 recorder
V-REC Recording on video tape
 recorder

TRACK

12	Track number on CD, audio tape or video tape; preset radio or TV station
>	Tuning up in frequency
<	Tuning down in frequency
>>	Fast forward (tape); search forward (CD)
<<	Rewind (tape); search backward (CD)
<>	Stop; TV/radio frequency range
AM	AM radio station
FM	FM radio station

Sound:

VOLUME	22	Volume level
BAL	- - -	Neutral balance
	1 - -	Balance adjusted toward the left
	- - 1	Balance adjusted toward the right
TREBLE	- -	Neutral treble
	+ 1	Increase in treble level
	- 1	Decrease in treble level
BASS	- -	Neutral bass
	+ 1	Increase in bass level
	- 1	Decrease in bass level
LOUDN ON/OFF		Loudness on/off

Status reading on recording

VOLUME SOURCE TRACK

Recording pause:

→	22	A-REC] Shown alternately at short intervals
	22	RADIO	3 ←	

Recording in progress:

	22	A-REC] Shown for 10 seconds after the recording has started and is then followed by
	22	RADIO	3 ←	

If, during a recording, you adjust the sound, the above sequence is repeated afterwards.

Missing source



LOAD

CD



Shown alternately 3 times at short intervals

Dynamic Clipping Attenuator

The Beolab Penta features a special circuit called Dynamic Clipping Attenuator.

Clipping is a form of output signal distortion which occurs in cases of severe overloading of the amplifier. The peaks of the audio waveform will be clipped if an amplifier is unable to reproduce extreme input levels (transients).

To resolve this problem, Bang & Olufsen developed the Dynamic Clipping Attenuator. It ensures that the clipping of the output signal takes place with much less audible distortion than would otherwise be the case.

Protection circuit

The Beolab Penta is equipped with a protection circuit which is automatically activated if something is wrong, e.g.

- if the amplifier unit is overheated,
- if a fault occurs in the amplifier which could damage the loud-speaker units.

If the protection circuit is activated, the sound disappears and the light on the front of the amplifier turns yellow.

Should this happen

- disconnect the Beolab Penta from the mains supply,
- allow the amplifier time to cool off,
- make sure that the ventilation to the amplifier is not impeded,
- reconnect the Beolab Penta to the mains supply.

If the light is still yellow, contact your Bang & Olufsen dealer. Do not cut the power supply in and out several times in a row.

Optional accessories

The accessories listed below are all available as optional extras from your Bang & Olufsen dealer.

Cables

	<i>Part No</i>
4-pin DIN shielded speaker cables	
5 m (16')	6270336
10 m (33')	6270352
8-pin DIN Power Link cables	
2.5 m (8')	6270417
5 m (16')	6270418
10 m (33')	6270419

2-pin DIN shielded speaker cable
5 m (16') 6270350

Adaptor for Power Link

8-pin DIN female/8-pin
DIN female 7229075

Maintenance

To make the stainless steel surfaces shiny, polish them thoroughly using a dry, soft cloth.

Remove fingerprints and grease stains using a mild detergent on a soft cloth.

Developing a Bang & Olufsen loudspeaker

For more than fifty years, we at Bang & Olufsen have been working at developing loudspeakers that combine a true-to-life sound reproduction and an innovative and unique design. In the process of research and development we draw on the skills of our in-house experts in acoustics, electronics and mechanical engineering. Their combined effort is aimed at developing prototypes which offer the best reproduction possible of tone balance and spatial impression.

Once produced, the prototype is subjected to a number of extensive tests. These tests enable us to see whether the loudspeaker's performance matches the conceptual idea, and if not, which modifications are required before the speaker is ready for production.

In pursuit of perfection, we use our highly sophisticated research facility: In a purpose-built cube-shaped test chamber (12 x 12 x 13 meter / 39' x 39' x 42') we analyze our speakers' performance under simulated free-field conditions. The test equipment and computers we

use are capable of registering even the most microscopic deviations from the ideal we have chosen, and we can measure every detail of the large number of factors affecting the sound quality of the speaker.

The purpose of a loudspeaker cabinet is to isolate the rear side acoustical emission of the speaker units from the front side emission. A loudspeaker cabinet is also designed to act as a supporting structure for the speaker units without contributing any sound itself. As it is important to minimize mechanical vibrations in the cabinet, we use a highly sophisticated technique called laser holography: By studying the three-dimensional picture produced during the holographic test, we can actually see where in the cabinet undesirable vibrations are produced, and we can then take the steps needed to dampen them.

The above-mentioned testing techniques can all be classified as "objective tests", because the performance of the loudspeaker is evaluated on the basis of data pro-

vided by advanced technological equipment. However, as we develop loudspeakers for the pleasure of the human ear – and not merely for the impersonal acceptance of a machine – we also carry out a number of "subjective" listening tests: In our reference room for listening tests we gather an audience of people from our well-trained listening panel whose ears are tuned to the fine nuances and details of sound. Their expert opinion and highly personal comments are of the utmost value to us in our research and development work, and their acceptance is needed before the speaker can be given the final seal of approval.

Your new speaker is proof that Bang & Olufsen has come close to perfection in both sound reproduction and design.

Technical specifications

Beolab Penta

Speaker:

Long term maximum power IEC	320 watts
Maximum noise power IEC	150 watts
Impedance	8 ohms
Frequency range +4/-8 dB	40-20,000 Hz
Power at 96 dB SPL (1 m)	2.5 watts
Sensitivity 1 W (1 m)	92 dB
Distortion 0.250 - 6 kHz	<0.5%
Cabinet principle	Bass Reflex
Woofer	4 units 13 cm (5")
Mid-range	4 units 8 cm (3")
Tweeter	2.5 cm (1")
Crossover frequency	700/5000 Hz
Net cabinet volume	32 litres

Power amplifier:

Long term maximum power IEC	300 watts
RMS DIN	175 watts
IHF	150 watts
Total harmonic distortion IHF	<0.015%
Intermodulation IHF	<0.02%
Dynamic headroom	>1.5 dB
Input sensitivity/impedance:	
POWER LINK sockets	1V/>25 kohms
- channel separation	>70 dB
SPEAKER LINK socket	11 V/>15 kohms
LINE IN socket	1 V/>25 kohms
BASS EXTENSION switch	0 dB, +3dB, +6 dB
INPUT LEVEL switch	0 dB, -3 dB, -6 dB
Dynamic Clipping Attenuator	Automatic
Power consumption	Max. 300 watts

Stand-by	2 watts
Dimensions W x H x D	22 x 165 x 20.5 cm (8 ³ / ₄ " x 65" x 8")
Dimensions, Stand	35.5 x 4 x 34 cm (14" x 1 ⁵ / ₈ " x 13 ³ / ₈ ")
Weight	24 kg (52.9 lbs)

Subject to change without notice

International guarantee

This Bang & Olufsen product carries a guarantee against defects in workmanship and materials. It is a national guarantee, extended by Bang & Olufsen to the country in which the product was bought. The terms of the guarantee apply principally to the country of purchase but will be met by authorized Bang & Olufsen dealers in other countries. The guarantee period applying to the country of purchase takes priority over guarantee periods applying in other countries, even where differences exist.

In order to obtain service under this guarantee, a certificate stating the following information is required:

- Name of product and type number
- Serial number
- Date of purchase
- Guarantee period
- Dealer's or supplier's signature

Bang & Olufsen
DK-7600 Struer
DENMARK

